



TRENDNET[®]



User's Guide

TPL-305E
1.01

Table of Contents

Chapter 1: Product Overview	3
1.1 Powerline Network Solution	3
1.2 Package Contents.....	3
1.3 System Requirements.....	4
1.4 Device Label	4
1.5 LEDs.....	5
1.6 Ethernet Ports	6
Chapter 2: Product Installation	7
2.1 Initial Installation	8
2.2 Securing your Powerline Network	9
2.3 Changing the Network Name/Security Key using the Sync Button	10
2.4 Adding the Powerline Adapter to an Existing Powerline Network	11
Chapter 3: Overlapping Powerline Networks	12
3.1 Move Powerline Adapters between different Powerline Networks.....	12
Chapter 4: Powerline Configuration Utility	13
4.1 Software Installation.....	13
4.2 Using the Utility.....	16
Chapter 5: Troubleshooting	19
Chapter 6: Specifications	20

Chapter 1: Product Overview

The TPL-305E 3-Port 200Mbps Powerline AV Adapter is an excellent solution that can be used to extend your network using your home or small office electrical wiring. In a home or small office building, use 3-Port 200Mbps Powerline AV adapters to link multiple locations without the need to run long Ethernet cables. Combined with a single broadband DSL/Cable Internet connection, every room with electrical power outlets can provide easy access to your high-speed Internet connection. With HomePlug® AV speeds of up to 200Mbps, this easy-to-setup solution can provide fast streaming HD movies, online multiplayer games, and other data intensive applications for today's HD Entertainment Center demand.

Each TPL-305E 3-Port 200Mbps Powerline AV Adapter allows you to connect up to three network enabled devices to a powerline network via Ethernet. In operation, the 3-Port 200Mbps AV Adapter is completely transparent, and simply passes data between the Ethernet port and the powerline network. Any Ethernet-enabled device may be connected to one of the three integrated 10/100Mbps Auto-MDIX Ethernet ports.

1.1 Powerline Network Solution

Add high-speed Internet access to any room in your home with this 3-Port 200Mbps Powerline AV Adapter. You can stream HD movies and music, play online multi-player games and much more. The TPL-305E has three integrated 10/100Mbps Auto-MDIX ports so up to three network enabled devices nearby can be networked simultaneously without the need for an additional switch.

Note: This TPL-305E 3-Port 200Mbps Powerline AV Adapter needs to pair with at least one other HomePlug® AV compatible powerline device. (e.g. TRENDnet Powerline AV products TPL-303E, TPL-304E, TPL-310AP, or another TPL-305E.)

1.2 Package Contents

The product package should contain the following items:

- TPL-305E
- Multi-Language Quick Installation Guide
- CD-ROM (Utility & User's Guide)
- Cat. 5 Ethernet Cable (1.5 m / 5 ft.)

If any of the parts are incorrect, missing, or damaged, contact your dealer. Keep the carton, including the original packaging materials, in case you need to return the Powerline adapter for repair.

1.3 System Requirements

- CD-ROM drive
- A Desktop or Laptop PC with Network Adapter Installed
- Existing 10/100Mbps wired network when TPL-305E is used as a bridge device
- Additional HomePlug® AV powerline adapter
(e.g. TRENDnet TPL-303E, TPL-304E, TPL-310AP, or another TPL-305E)

Powerline Configuration Utility System Requirements

Supported Operating Systems	CPU	Memory
Windows 7 (32/64-bit)	1GHz or above	1GB RAM or above
Windows Vista (32/64-bit)	800MHz or above	512MB RAM or above
Windows XP (32/64-bit)	300MHz or above	256MB RAM or above

1.4 Device Label

The device label can be located on the back of the device where the power prong is found.

Product Model → **TRENDnet**
 Device Serial Number → MODEL NO: TPL-305E/A
 S/N: [Barcode]
 Device MAC Address → MAC:
 Device Password (DPW) → DPW: VARS-ECHE-SAGA-OWED
 Product Hardware Version → H/W: V1.0R
 Product Firmware Version → F/W:
 This device complies with Part 15 of FCC Rules.
 Made in China

FC CE
 RoHS

1.5 LEDs

The LED panel located on the front of the device consists of the status LEDs, Sync button, and Reset button.

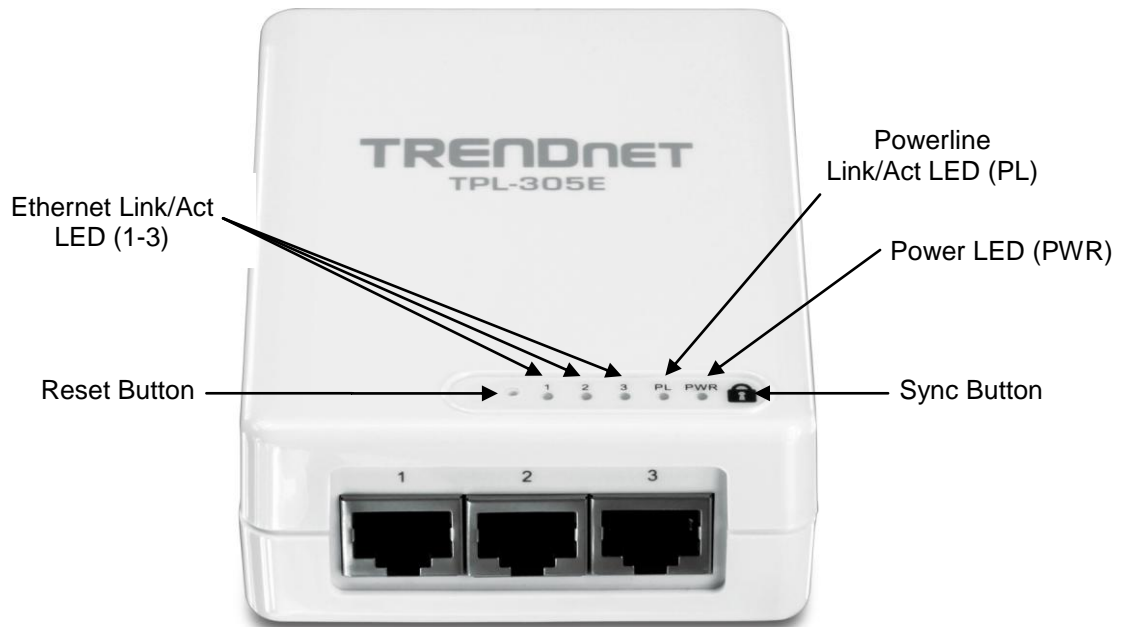

LED	Color	Sequence	Definition
PWR (Power)	Green	Solid	Device powered On
	N/A	Off	Device powered Off
PL (Powerline) Note: LED color indicates the strength and quality of the powerline connection through the electrical system	Green	Solid	Powerline Connected (Connection Quality is Best)
		Blinking	Syncing or Powerline Data Transmitting/Receiving (Connection Quality is Best)
	Amber	Solid	Powerline Connected (Connection Quality is Better)
		Blinking	Powerline Data Transmitting/Receiving (Connection Quality is Better)
	Red	Solid	Powerline Connected (Connection Quality is Good)
		Blinking	Powerline Data Transmitting/Receiving (Connection Quality is Good)
N/A	Off	Powerline is not synced or connected	
1-3 (Ethernet Port)	Green	Solid	10/20 Mbps or 100/200Mbps (Half/Full Duplex) Connected (per port)
		Blinking	10/20Mbps or 100/200Mbps (Half/Full Duplex) Data Transmitting/Receiving (per port)
	N/A	Off	Port Disconnected/No Ethernet Link
Button	Action		Function
 (Sync)	Push/Hold for 2 sec		Initiate Sync/Connection and generate random network name/key on first adapter (PWR LED will start blinking)
			Match network name/key on secondary or additional adapter and connect to first adapter. (PWR LED will start blinking)
			Note: The secondary or additional powerline adapter's Sync button must also be pushed within 2 minutes (120 sec) of pushing the Sync button of the first adapter in order to establish connectivity.
	Push/Hold for 10 sec		Erases the network name/key (All LEDs will turn off and turn back on)
Reset	Push/Hold for 1 sec		Reset device to factory defaults (All LEDs will turn off and turn back on) Note: Will reset to the factory default private network name "HomePlugAV"

*Note: The following factors may affect the powerline network's connection quality:

- Noise – Generated by appliances that are connected to your electrical system through power outlets that have high power consumption requirements. (e.g. Microwaves, ovens, blow dryer, iron, dishwasher, etc.) The quality of your household electrical wiring may also cause additional noise on your electrical system.
- Distance – Long lengths of electrical wiring through your electrical system between connected powerline adapters.

1.6 Ethernet Ports

There are three RJ-45 10/100Mbps Auto-MDIX Ethernet ports at the bottom of the device for network connectivity to computers and network appliances (e.g. Game Console, IP Set Top Box, network enabled TV, etc.) using the included Cat. 5 Ethernet cable.

Ethernet Ports



Chapter 2: Product Installation

At factory default settings, a pair of TPL-305E 3-Port 200Mbps Powerline AV adapters can be installed into any room in your home or small office with a wall power outlet, without the need for additional software or configuration. To create a simple powerline network using a pair TPL-305E powerline adapters, simply plug one of your TPL-305E adapters into a wall power outlet in one room and plug the other TPL-305E adapter into an available wall power outlet in another room to establish connectivity between the two rooms.

In order to share Internet connectivity through your powerline adapters, it is ideal to install at least one powerline adapter in the room where your modem and router are located and connect the powerline adapter to one of your router's LAN ports via Ethernet. Any additional powerline adapters that are installed and connected in other rooms will then share Internet connectivity through your router. Once the powerline adapters are connected to each other through the electrical system, any additional devices such as computers or network appliances (e.g. Game Console, Blu-ray player, IP Set Top Box, network enabled TV, etc.) connected to any of your powerline adapters via Ethernet can then communicate to each other as well as share Internet connectivity through your router.

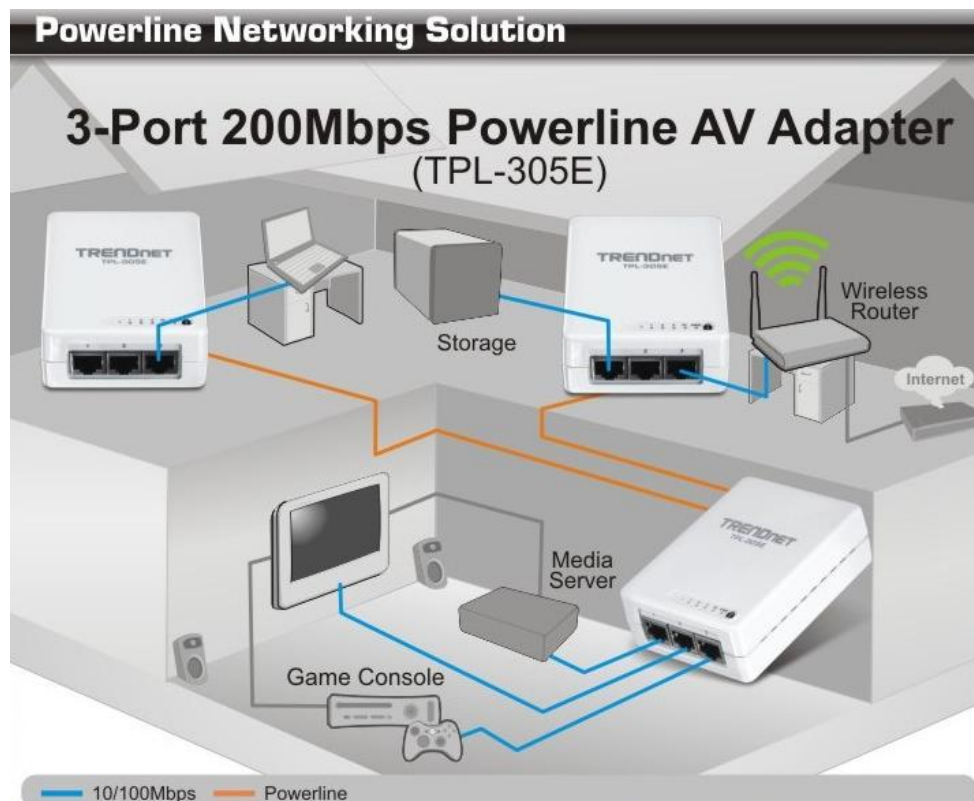

The example diagram shows a typical powerline network configuration in a home environment with 3 powerline adapters installed in different rooms. The orange line represents the powerline connectivity established through your home's electrical system and the blue lines represent Cat. 5, 5e, 6 Ethernet connectivity to your network enabled appliances such as a computer, router, or IP set top box connected to your television.

2.1 Initial Installation

The procedure describes how to create a basic powerline network between a pair of TPL-305E powerline adapters and share Internet connection through a router to computers or network appliances in another room.

Assuming your router is already installed and configured for Internet connectivity and the TPL-305E powerline adapters are at factory default settings.

1. Plug one of the TPL-305E powerline adapters into an available wall power outlet in the room where your router is located.

Warning: Do not plug the powerline adapter into a power strip that has surge protection. Doing so will degrade power line performance. For best performance, plug all powerline adapters directly into a wall power outlet.

2. Connect one end of the Ethernet Cable into one of the Ethernet ports located at the bottom of the TPL-305E and connect the other end of the Ethernet cable into one of the router's LAN ports.
3. Plug the second TPL-305E powerline adapter into an available wall power outlet in another room where your computer or network appliance (e.g. Game Console, Blu-ray player, IP Set Top Box, network enabled TV, etc.) is located.
4. Connect one end of the Ethernet Cable into one of the Ethernet ports located at the bottom of the second TPL-305E and the other end of the Ethernet cable into the Ethernet port on your computer or network appliance (e.g. Game Console, Blu-ray player, IP Set Top Box, network enabled TV, etc.).
5. To verify connectivity between the TPL-305E powerline adapters, make sure that the PL LED on each TPL-305E is on solid (Green, Amber, Red). Please refer to the LED section 1.5 for details on the LED indicator.
6. You have successfully created a basic powerline network between a pair of TPL-305E powerline adapters. All computers or network appliances connected to the powerline adapters via Ethernet can now communicate to each other as well as access the Internet.

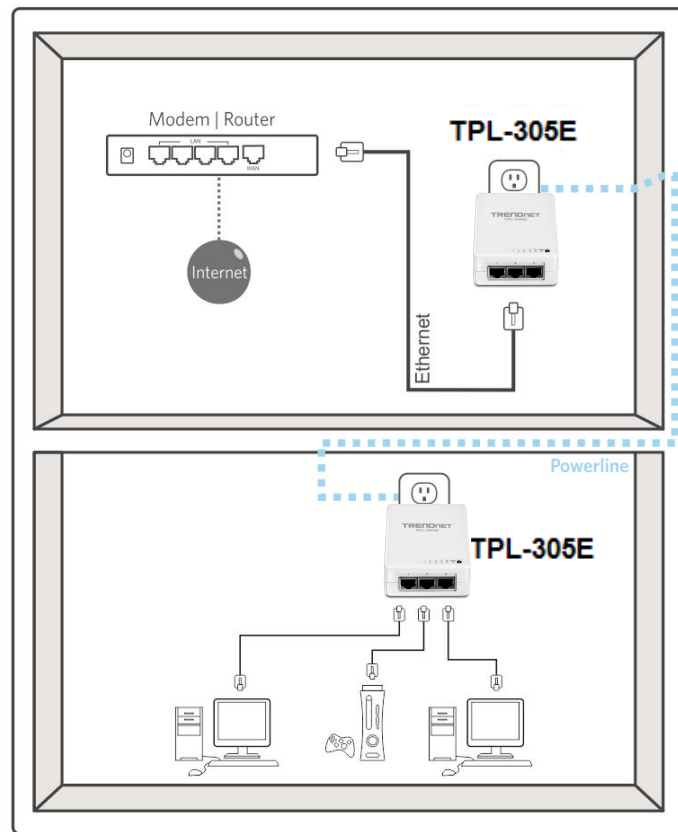

2.2 Securing your Powerline Network

The TPL-305E 3-Port 200Mbps Powerline AV Adapter has a default network name/security key assignment of “HomePlugAV”. When connecting a pair of TPL-305E powerline adapters, both powerline adapters will be assigned the default network/security key which allows the TPL-305E powerline adapters to establish connectivity through your home or small office’s electrical system without the need for additional software or configuration. For added security, the default network name/security key can be modified using the TPL-305E Sync button  covered in the following section or through the use of the Powerline Configuration Utility in Chapter 4.



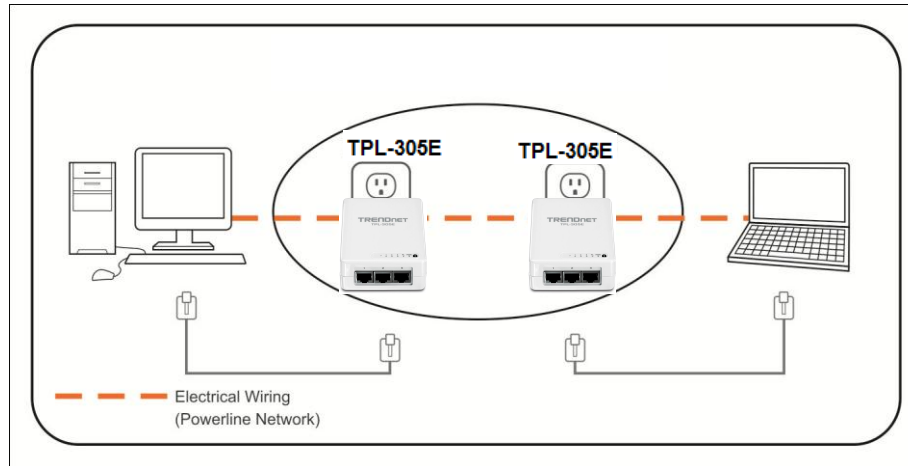

Note: The default network name/security key assigned to the TPL-305E is “HomePlugAV”. All powerline adapters in the same powerline network must have the same network name/security key in order to establish connectivity. If the network name/security keys are not the same for all powerline adapters on the same powerline network, the adapter will NOT establish connectivity. TRENDnet Powerline AV models TPL-303E, TPL-304E, TPL-305E, TPL-310AP, and TPL-401E all have the same default network name/security key assignment of “HomePlugAV”.

2.3 Changing the Network Name/Security Key using the Sync Button

The procedure describes how to change the network name/security key between a pair of TPL-305E powerline adapters. This procedure can also be used to establish connectivity between two powerline adapters that are currently disconnected and change the default network name/security key simultaneously.



Assuming your TPL-305E powerline adapters are already plugged into wall power outlets and either currently connected or disconnected to each other.



1. Push and hold the Sync button  on one of the TPL-305E powerline adapters for 10 seconds and release it. All LEDs will turn off and turn back on. This will erase the current network name/security key assigned to the first powerline adapter.
2. Push and hold the Sync button  on the other TPL-305E powerline adapter for 10 seconds and release it. All LEDs will turn off and turn back on. This will erase the current network name/security key assigned to the second powerline adapter.
3. Push and hold the Sync button  on the first TPL-305E powerline adapter for 2 seconds and release it. The PWR LED will start blinking. This will initiate sync/connection and generate a random network name/security key assignment to the first powerline adapter.
4. Within 2 minutes (120 sec), push and hold the Sync button  on the second TPL-305E powerline adapter for 2 seconds and release it. The PWR LED will start blinking. This will establish connectivity between the two powerline adapters by assigning the second powerline adapter's network name/security key to match the network name/security key of the first powerline adapter.
5. To verify connectivity between the two powerline adapters, make sure that the PL LED on each powerline adapter is on solid (Green, Amber, Red). Please refer to the LED section 1.5 for details on the LED indicator.

2.4 Adding the Powerline Adapter to an Existing Powerline Network

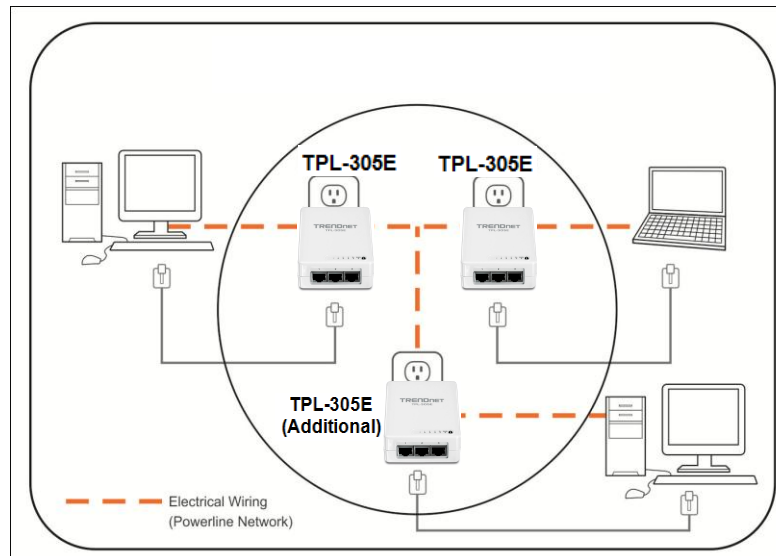
The procedure describes how to add the TPL-305E 3-Port 200Mbps Powerline AV Adapter to an existing powerline network.



Assuming the two TPL-305E powerline adapters are currently connected to each other and the third TPL-305E (Additional) powerline adapter is currently disconnected.

1. Push and hold the Sync button  on the additional TPL-305E powerline adapter for 10 seconds and release it. All LEDs will turn off and turn back on. This will erase the current network name/security key assigned to the additional TPL-305E powerline adapter.
2. Push and hold the Sync button  on one of the two TPL-305E powerline adapters that are currently connected to each other for 2 seconds. The PWR LED will start blinking.
3. Within 2 minutes (120 sec), push and hold the Sync button  on the additional TPL-305E for 2 seconds and release it. The PWR LED will start blinking. This will establish connectivity between the three powerline adapters by assigning the additional TPL-305E powerline adapter's network name/security key to match the network name/security key of the TPL-305E powerline adapters that are currently connected.
4. To verify connectivity between the three powerline adapters, make sure that the PL LED on each powerline adapter is on solid (Green, Amber, Red). Please refer to the LED section 1.5 for details on the LED indicator.

Chapter 3: Overlapping Powerline Networks

It is possible to create multiple powerline networks on the same electrical system separated and grouped by different network names/security keys. The powerline networks will work and communicate independently of each other which can provide security between different groups of powerline adapters. For example, if you have five powerline adapters (Adapter A, Adapter B, Adapter C, Adapter D, Adapter E), you can group Adapters A, B, and C together on one powerline network and group Adapters D and E on a different powerline network. Each group will use a different network name/security key.



Note: It is recommended that only a maximum of up to 4 powerline networks can be created per electrical system. Any additional powerline networks above the recommended result in significant degradation in powerline performance.

3.1 Move Powerline Adapters between different Powerline Networks

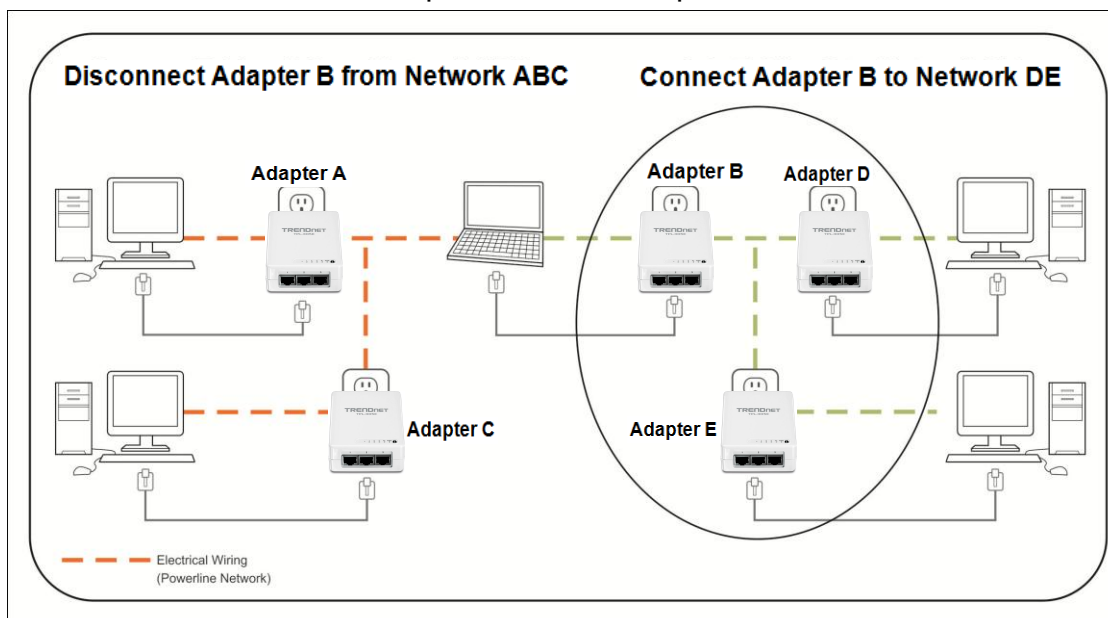
Use the procedures in Chapter 2: Product Installation, to connect one group of adapters, then you can carry out the procedures on another group of adapters to create multiple overlapping powerline networks. This procedure describes how to disconnect a powerline adapter from one powerline network and connect the adapter to a different powerline network.



Assuming all powerline adapters are TPL-305E adapters and for reference in the diagram and this procedure, the adapters will be labeled *Adapter A*, *B*, *C*, *D*, and *E*. *Adapters A*, *B*, and *C* are currently connected together to form one powerline network and *Adapters D* and *E* form another powerline network. *Adapter B* will be disconnected from *Adapters A* and *C* and connected to *Adapters D* and *E*.

1. Push and hold the Sync button  on *Adapter B* for 10 seconds and release it. All LEDs will turn off and turn back on. This will erase the current network name/security key assigned to *Adapter B* and disconnect from *Adapters A* and *C*.
2. Push and hold the Sync button  on *Adapter D* for 2 seconds and release it. The PWR LED will start blinking.
3. Within 2 minutes (120 sec), push and hold the Sync button  on *Adapter B* for 2 seconds then release it. The PWR LED will start blinking. This will establish connectivity between

Adapters B, D, and E by assigning Adapter B's network name/security key to match the network name/security key of Adapters D and E.

4. To verify connectivity between the powerline adapters, make sure that the PL LED on each powerline adapter is on solid (Green, Amber, Red). Please refer to the LED section 1.5 for details on the LED indicator.

Chapter 4: Powerline Configuration Utility

The Powerline Configuration Utility is an additional tool that allows you to centrally manage the powerline adapters that are connected to your network. Instead of using a randomly generated key with the Sync button, the utility allows you to manually configure the network name/security key for a single powerline adapter or multiple adapters simultaneously. This tool allows for easy management for multiple powerline adapters in your network.

Note:

1. Before installing and using the utility, write down the 16-digit Device Password (DPW) and MAC Address of each TPL-305E powerline adapter as this will be required to apply changes to remote devices discovered in the utility. This is located on the Device Label, please refer to Section 1.4.
2. Before installing and using the utility, make sure your computer in which you are installing the utility is connected to your network and your TPL-305E adapters are also connected to your network.
3. Make sure all of the TPL-305E powerline adapters are already connected to each other using the procedures in Chapter 2: Product Installation.
4. The utility is only compatible with Windows operating systems. For details, please refer to Section 1.3.

4.1 Software Installation

1. Insert the included CD-ROM into your computer's CD-ROM drive.
2. At the CD Autorun Prompt window, click *Run Autorun.exe*
3. At the CD-ROM menu window, click *Install Utility*.



4. At the WinPcap installer window, click *Next*.

Note: The Powerline Configuration Utility requires the use of the WinPcap application. If this prompt does not appear, you may already have the WinPcap application installed. If so, please skip over to Step 10.

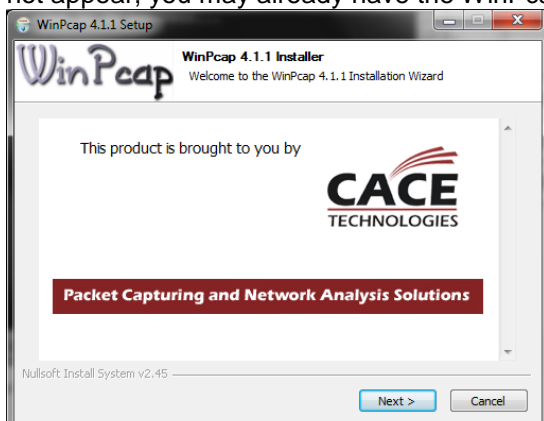

5. In the Setup Wizard window, click *Next*.



6. In the License Agreement window, click *I Agree*.

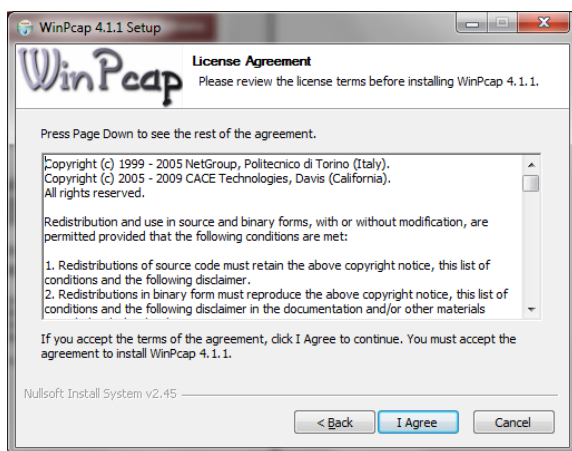

7. In the Install Options window, click *Install*.

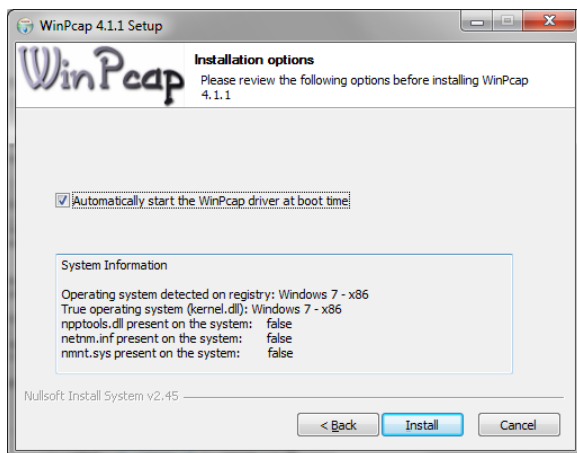

8. At the Setup Wizard Completion window, click *Finish*.

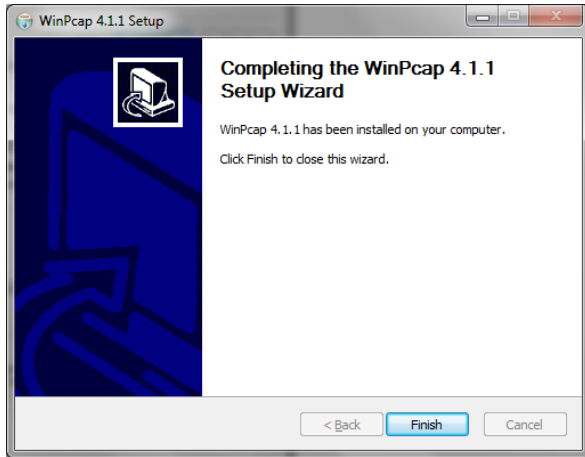

9. The TRENDnet Powerline Configuration Utility installation window will appear automatically. At the Setup Wizard window, click *Next*.

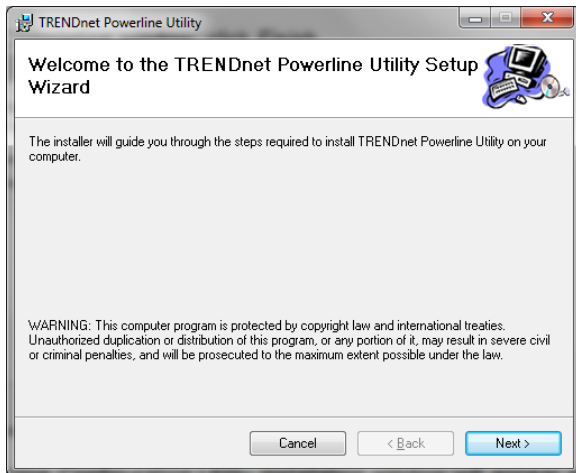

10. In the License Agreement window, check the radio button *I Agree*, and then click *Next*.

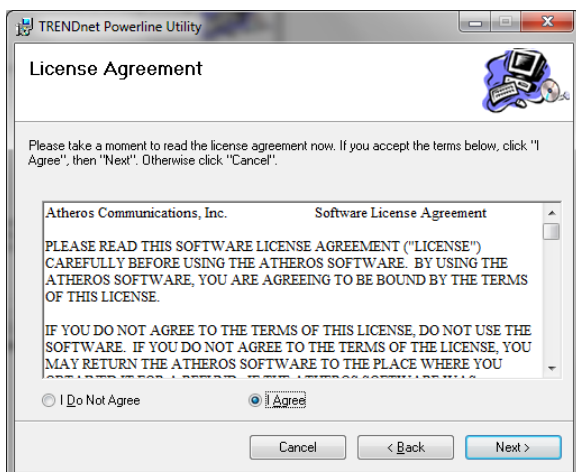

11. In the Select Installation Folder window, click *Next*.

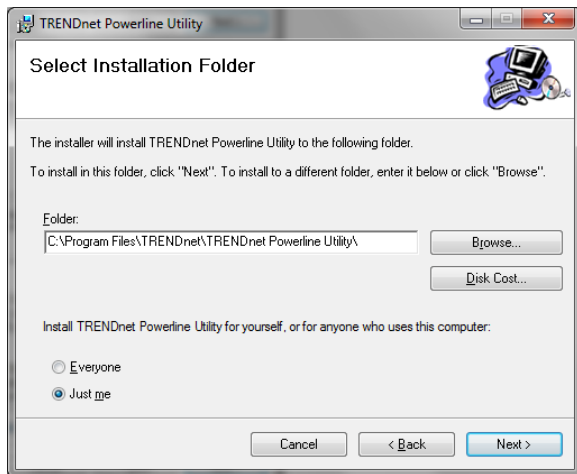

12. In the *Confirm Installation* window, click *Next*.

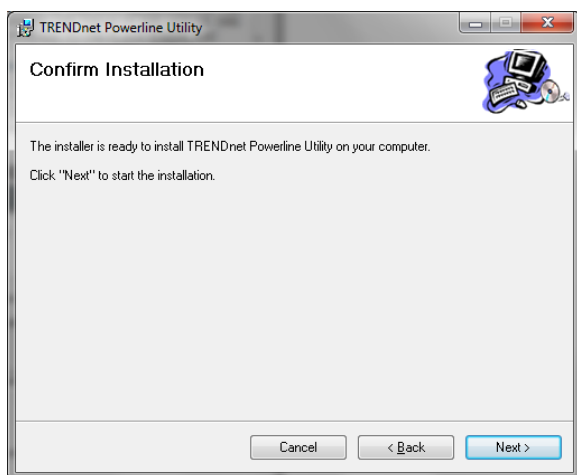

13. At the Installation Complete window, click *Close*.

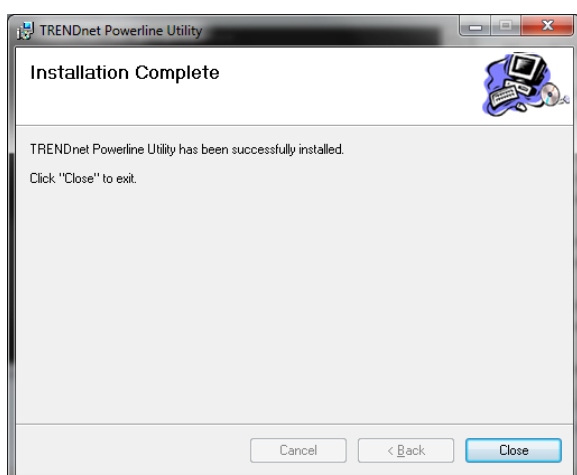

4.2 Using the Utility

Double-click the desktop icon to open the Powerline Configuration Utility application.



Local Device
The closest powerline adapter(s) that connects your computer to the electrical system.

Remote Devices
Powerline adapters that are connected to the selected Local Device across the electrical system.

Privacy Tab
Change the Network Name/Security Key

Closes the utility application.

Rename the selected Remote Device

Enter the Device Password (DPW) for the selected Remote Device

Add a Remote Device that was not detected

Scans for Remote Devices that were not detected

- To apply changes to Remote Devices through the Powerline Configuration Utility, you must enter the Device Password (DPW) for each Remote Device located on the Device Label.
- If you have not already done so, please write down the 16-digit Device Password (DPW) and corresponding MAC Address of each TPL-305E powerline adapter as this will be required to apply changes to remote devices discovered in the utility. This is located on the Device Label, please refer to Section 1.4.

Enter the 16-digit Device Password (DPW) for each Remote Device in the utility

1. Click one of the Remote Devices in the list.
2. Click *Enter Password*.
3. Type in the Device Password according to the corresponding MAC address. Then click *OK*.



- If successful, the Remote Device will have the Device Password listed next to the device under Password.

Note: If the incorrect Device Password is entered, you will receive an error message. Click *Enter Password* and try entering the password again.

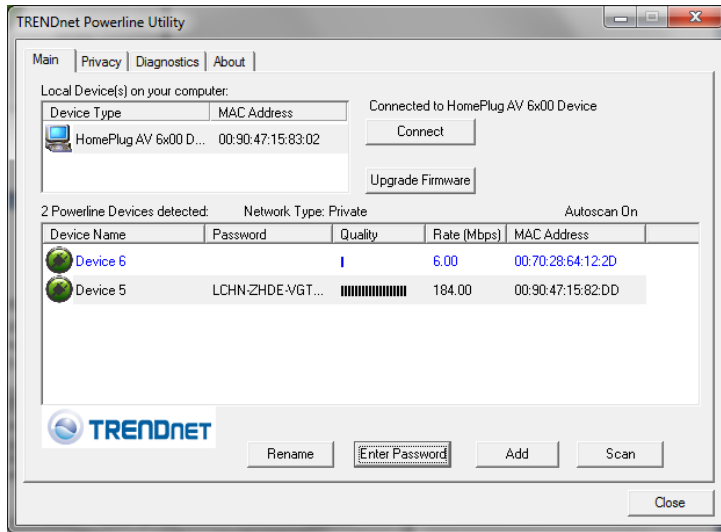

- Repeat steps 1-4 for any remaining Remote Devices.
- Once all of the Device Passwords (DPW) are entered into the utility, changes can be applied to the Remote Devices using the utility.

Change the Network Name/Security Key for multiple adapters using the utility

- Click the *Privacy* tab.
- Under *Private Network Name*, enter the desired network name/security key and click *Set All Devices*.
- At the Network Name Setting prompt window, click *OK*.

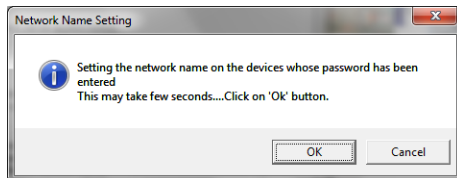

The current network name/security key assignment of the powerline adapter(s).

Note: If you had previously used the Sync button procedure in generating a random network name/security key. This will display "Unknown Networkname"

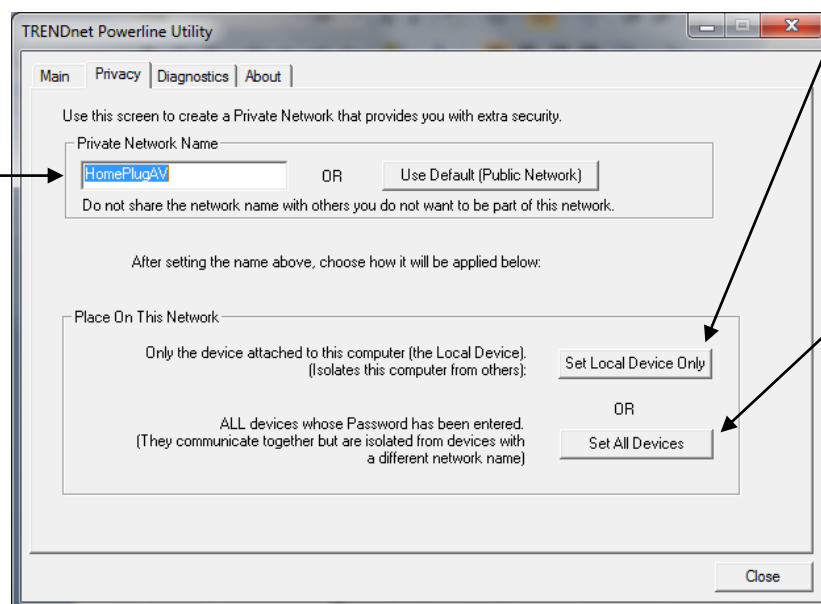

Applies changes to Local Device only.

Note: If you choose this option, you will disconnect the Local Device from the Remote Devices.

Applies changes to Local Device and Remote devices.

Note: If you have not entered the DPW for all remote devices, you will receive an error and the changes will not be applied to remote devices without a DPW.

Chapter 5: Troubleshooting

Please reference the items below if you continue to experience difficulty with installing and using your TPL-305E 3-Port 200Mbps Powerline AV Adapter.

- Try power cycling the unit by unplugging it from the wall power outlet for 15 seconds and plugging it back in.
- If the PL LED is red indicating good quality only, try plugging the TPL-305E into another available wall power outlet to check if you can obtain better connection quality.
- Use a pin or paperclip and push and hold the Reset button for 1 second on each TPL-305E powerline adapter. All LEDs will turn off and turn back on. This will reset the TPL-305E powerline adapters to the default settings, network name/security key assignment “HomePlugAV”.
- The TPL-305E can provide better connectivity and performance when plugged directly into the wall power outlet instead of a power strip or surge protector.
- Connecting the TPL-305E to a power strip or surge protector may degrade network performance or completely stop network signals.
- The TPL-305E should not be used on GFI protected outlets as some outlets will filter out powerline signals.
- The TPL-305E should not be used in areas with excessive heat.
- Certain florescent or incandescent lights are noise sources on the electrical and can degrade powerline performance.
- If your building has more than one circuit breaker box, the TPL-305E may not be able to establish connectivity between different circuit breaker boxes. In this case, connect a TPL-305E powerline adapter to a power outlet located on each of the circuit breaker boxes, and then connect an Ethernet cable between the TPL-305E powerline adapters to bridge the two circuits together. This will allow the TPL-305E powerline adapters from different circuit breaker boxes connect to each other.

Power Saving: The device will automatically reduce power usage when the connected devices via Ethernet are powered off, unplugged or inactive for more than 2 minutes.

Erp (EuP) Operation: Standby Mode

- Disconnect the Ethernet cables from the device Ethernet ports, and after 3 minutes, the device will enter standby mode. The Power (PWR) LED will flash every 15 seconds to indicate that the device is currently in standby mode.
- To return to active mode, reconnect the Ethernet cables to the device Ethernet ports, and the device will re-enter active mode.

Chapter 6: Specifications

Hardware	
Standards	IEEE 802.3, IEEE 802.3x, IEEE 802.3u, HomePlug® AV
Interface	3 x 10/100Mbps Auto-MDIX RJ-45 ports, Power prong
Frequency Band	2 ~ 28 MHz
Modulation	OFDM Symbol Modulation on link synchronization, 1024/256/64/8 - QAM, QPSK, BPSK, ROBO Carrier
Protocol	TDMA, and CSMA/CA
Speed	Powerline: Up to 200Mbps** Ethernet: Up to 200Mbps (Full Duplex mode)
Utility OS Compatibility	Windows 7 (32/64-bit), Vista (32/64-bit), XP(32/64-bit)
Nodes	Up to 64 max. Recommended: up to 16* per Powerline network
Overlapping Powerline Networks	Up to 4 (per electrical system)
Coverage	Up to 300m (984ft.)
Security	128-Bit AES (Advanced Encryption Standard)
LED	Power (PWR), Ethernet Link/Act (1-3) Powerline (PL) with Connection Quality Indication <ul style="list-style-type: none"> • Best (Green) • Better (Amber) • Good (Red)
Buttons	Sync, Reset
Dimension (L x W X H)	A: 103 x 74 x 57 mm (4.1 x 2.9 x 2.2 in.) EU: 103 x 74 x 72 mm (4.1 x 2.9 x 2.8 in.)
Weight	A: 165 g (5.8 oz) EU: 170 g (6.0 oz)
Power Source	A: 100~230V AC, 50~60Hz EU: 220~240V/ 5A AC, 50Hz
Consumption	Active mode: 3.2 Watts (max.) Standby mode: 0.9 Watts (max.)
Temperature	Operating: 0° ~ 40°C (32° ~ 104°F) Storage: -20° ~ 70°C (-4° ~ 158°F)
Humidity	Max. 90% (non-condensing)
Certifications	CE, FCC

* Maximum of 16 adapters (nodes) recommended for streaming video across your network. Additional adapters may decrease performance.

** 200Mbps is the maximum theoretical Powerline data rate. Actual throughput will vary depending on environment.

*** Networked Powerline devices need to be plugged into power outlets that are on the same electrical system.

Limited Warranty

TRENDnet warrants its products against defects in material and workmanship, under normal use and service, for the following lengths of time from the date of purchase.

TPL-305E – 3 Years Warranty

AC/DC Power Adapter, Cooling Fan, and Power Supply carry 1 year warranty.

If a product does not operate as warranted during the applicable warranty period, TRENDnet shall reserve the right, at its expense, to repair or replace the defective product or part and deliver an equivalent product or part to the customer. The repair/replacement unit's warranty continues from the original date of purchase. All products that are replaced become the property of TRENDnet. Replacement products may be new or reconditioned. TRENDnet does not issue refunds or credit. Please contact the point-of-purchase for their return policies.

TRENDnet shall not be responsible for any software, firmware, information, or memory data of customer contained in, stored on, or integrated with any products returned to TRENDnet pursuant to any warranty.

There are no user serviceable parts inside the product. Do not remove or attempt to service the product by any unauthorized service center. This warranty is voided if (i) the product has been modified or repaired by any unauthorized service center, (ii) the product was subject to accident, abuse, or improper use (iii) the product was subject to conditions more severe than those specified in the manual.

Warranty service may be obtained by contacting TRENDnet within the applicable warranty period and providing a copy of the dated proof of the purchase. Upon proper submission of required documentation a Return Material Authorization (RMA) number will be issued. An RMA number is required in order to initiate warranty service support for all TRENDnet products. Products that are sent to TRENDnet for RMA service must have the RMA number marked on the outside of return packages and sent to TRENDnet prepaid, insured and packaged appropriately for safe shipment. Customers shipping from outside of the USA and Canada are responsible for return shipping fees. Customers shipping from outside of the USA are responsible for custom charges, including but not limited to, duty, tax, and other fees.

WARRANTIES EXCLUSIVE: IF THE TRENDNET PRODUCT DOES NOT OPERATE AS WARRANTED ABOVE, THE CUSTOMER'S SOLE REMEDY SHALL BE, AT TRENDNET'S OPTION, REPAIR OR REPLACE. THE FOREGOING WARRANTIES AND REMEDIES ARE EXCLUSIVE AND ARE IN LIEU OF ALL OTHER WARRANTIES, EXPRESSED OR IMPLIED, EITHER IN FACT OR BY OPERATION OF LAW, STATUTORY OR OTHERWISE, INCLUDING WARRANTIES OF MERCHANTABILITY AND FITNESS FOR A PARTICULAR PURPOSE. TRENDNET NEITHER ASSUMES NOR AUTHORIZES ANY OTHER PERSON TO ASSUME FOR IT ANY OTHER LIABILITY IN CONNECTION WITH THE SALE, INSTALLATION MAINTENANCE OR USE OF TRENDNET'S PRODUCTS.

TRENDNET SHALL NOT BE LIABLE UNDER THIS WARRANTY IF ITS TESTING AND EXAMINATION DISCLOSE THAT THE ALLEGED DEFECT IN THE PRODUCT DOES NOT EXIST OR WAS CAUSED BY CUSTOMER'S OR ANY THIRD PERSON'S MISUSE, NEGLIGENCE, IMPROPER INSTALLATION OR TESTING, UNAUTHORIZED ATTEMPTS TO REPAIR OR MODIFY, OR ANY OTHER CAUSE BEYOND THE RANGE OF THE INTENDED USE, OR BY ACCIDENT, FIRE, LIGHTNING, OR OTHER HAZARD.

LIMITATION OF LIABILITY: TO THE FULL EXTENT ALLOWED BY LAW TRENDNET ALSO EXCLUDES FOR ITSELF AND ITS SUPPLIERS ANY LIABILITY, WHETHER BASED IN CONTRACT OR TORT (INCLUDING NEGLIGENCE), FOR INCIDENTAL, CONSEQUENTIAL, INDIRECT, SPECIAL, OR PUNITIVE DAMAGES OF ANY KIND, OR FOR LOSS OF REVENUE OR PROFITS, LOSS OF BUSINESS, LOSS OF INFORMATION OR DATA, OR OTHER FINANCIAL LOSS ARISING OUT OF OR IN CONNECTION WITH THE SALE, INSTALLATION, MAINTENANCE, USE, PERFORMANCE, FAILURE, OR INTERRUPTION OF THE POSSIBILITY OF SUCH DAMAGES, AND LIMITS ITS LIABILITY TO REPAIR, REPLACEMENT, OR REFUND OF THE

PURCHASE PRICE PAID, AT TRENDNET'S OPTION. THIS DISCLAIMER OF LIABILITY FOR DAMAGES WILL NOT BE AFFECTED IF ANY REMEDY PROVIDED HEREIN SHALL FAIL OF ITS ESSENTIAL PURPOSE.

Governing Law: This Limited Warranty shall be governed by the laws of the state of California.

Some TRENDnet products include software code written by third party developers. These codes are subject to the GNU General Public License ("GPL") or GNU Lesser General Public License ("LGPL").

Go to <http://www.trendnet.com/gpl> or <http://www.trendnet.com> Download section and look for the desired TRENDnet product to access to the GPL Code or LGPL Code. These codes are distributed WITHOUT WARRANTY and are subject to the copyrights of the developers. TRENDnet does not provide technical support for these codes. Please go to <http://www.gnu.org/licenses/gpl.txt> or <http://www.gnu.org/licenses/lgpl.txt> for specific terms of each license.

PWP05202009v2



TRENDNET[®]

Product Warranty Registration

Please take a moment to register your product online.
Go to TRENDnet's website at <http://www.trendnet.com/register>